



Date: _____ Type: _____

Firm Name: _____

Project: _____

eW Cove QLX Powercore

Performance interior linear LED cove and accent fixture with solid white light

Ordering Information

eW Cove QLX Powercore is a dimmable, linear LED fixture that provides an affordable, energy-efficient alternative to traditional cove lighting in applications requiring white light. With its low profile, rotating housing and flexible end-to-end locking power connectors, eW Cove QLX Powercore is the perfect choice for a wide range of interior retail, exhibit, hospitality, and architectural settings.

- Industry-best white-light quality and color consistency — Advances in Optibin, Philips proprietary binning optimization process, now provides color-consistency within a 2-step MacAdam ellipse across eW Cove product fixtures and manufacturing runs.
- Uncompromised Performance — Efficacies of near 100 lm/w provide optimum output without restrictions on lumen maintenance, operating temperature or warranty.
- Multiple options for design flexibility — Available in four color temperatures ranging from a warm 2700 K to a cool 4000 K. Lengths of 152 mm (6 in), 305 mm (12 in), and 1220 mm (48 in), wide and medium beam angles, and two power levels offer further design flexibility.
- Support for multiple voltages — Accepts power input of 120, 220 – 240, or 277 VAC for consistent installation and operation from line voltage in many locations.

Smooth dimming capability — Patented DIMand technology offers smooth dimming capability with selected reverse-phase ELV-type dimmers.

For detailed product information, please refer to the eW Cove QLX Powercore Product Guide at www.philipscolorkinetics.com/ls/essentialwhite/ewcoveqlxpc/

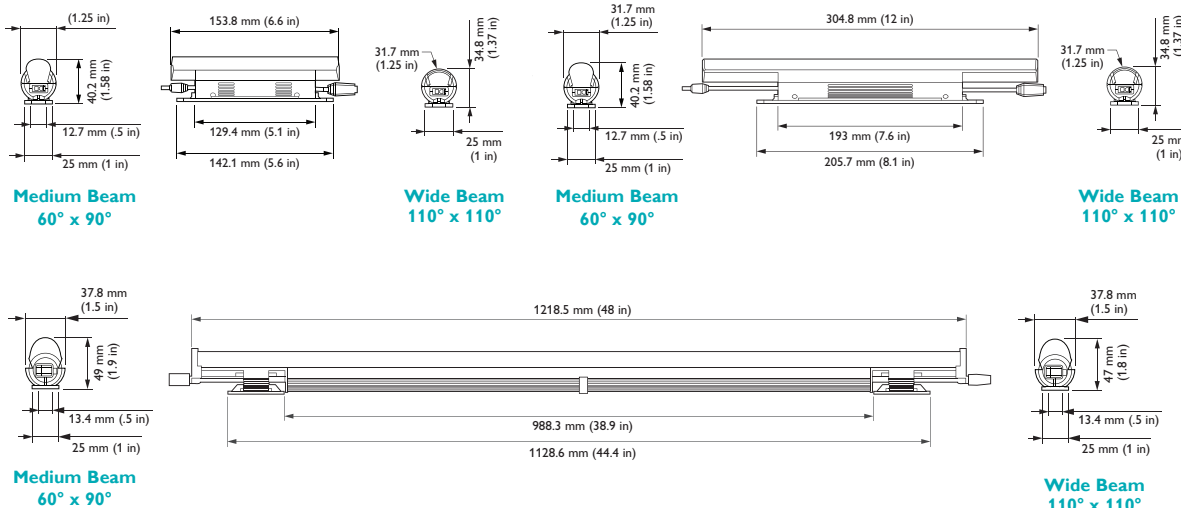

Ordering Information - 3500 K*, Wide Beam (110° x 110°)

	Power Level	152 mm (6 in)		305 mm (12 in)		1220 mm (48 in)	
		Item Number	Philips 12NC	Item Number	Philips 12NC	Item Number	Philips 12NC
eW Cove QLX Powercore 120 VAC	High	523-000090-50	910503705117	523-000091-50	910503705197	523-000092-50	910503705278
	Low	523-000090-18	910503705084	523-000091-18	910503705165	523-000092-18	910503705246
eW Cove QLX Powercore 220-240 VAC	High	523-000090-58	910503705125	523-000091-58	910503705206	523-000092-58	910503705286
	Low	523-000090-26	910503705092	523-000091-26	910503705173	523-000092-26	910503705254
eW Cove QLX Powercore 220-240 VAC Fixture and 3 m (10 ft) Leader Cable with terminator	High	523-000090-66	910503705133	523-000091-66	910503705214	523-000092-66	910503705294
	Low	523-000090-34	910503705101	523-000091-34	910503705181	523-000092-34	910503705262
eW Cove QLX Powercore 277 VAC	High	523-000090-74	910503705141	523-000091-74	910503705222	523-000092-74	910503705303
	Low	523-000090-42	910503705109	523-000091-42	910503705189	523-000092-42	910503705270

Use Item Number when ordering in North America.

Ordering Information - 3500 K*, Medium Beam (60° x 90°)

	Power Level	152 mm (6 in)		305 mm (12 in)		1220 mm (48 in)	
		Item Number	Philips 12NC	Item Number	Philips 12NC	Item Number	Philips 12NC
eW Cove QLX Powercore 120 VAC	High	523-000090-54	910503705121	523-000091-54	910503705202	523-000092-54	910503705282
	Low	523-000090-22	910503705088	523-000091-22	910503705169	523-000092-22	910503705250
eW Cove QLX Powercore 220-240 VAC	High	523-000090-62	910503705129	523-000091-62	910503705210	523-000092-62	910503705290
	Low	523-000090-30	910503705096	523-000091-30	910503705177	523-000092-30	910503705258
eW Cove QLX Powercore 220-240 VAC Fixture and 3 m (10 ft) Leader Cable with terminator	High	523-000090-70	910503705137	523-000091-70	910503705218	523-000092-70	910503705298
	Low	523-000090-38	910503705105	523-000091-38	910503705185	523-000092-38	910503705266
eW Cove QLX Powercore 277 VAC	High	523-000090-78	910503705145	523-000091-78	910503705226	523-000092-78	910503705305
	Low	523-000090-46	910503705113	523-000091-46	910503705193	523-000092-46	910503705272

Use Item Number when ordering in North America.

Ordering Information - 4000 K*, Wide Beam (110° x 110°)

	Power Level	152 mm (6 in)		305 mm (12 in)		1220 mm (48 in)	
		Item Number	Philips 12NC	Item Number	Philips 12NC	Item Number	Philips 12NC
eW Cove QLX Powercore 120 VAC	High	523-000090-51	910503705118	523-000091-51	910503705198	523-000092-51	910503705279
	Low	523-000090-19	910503705085	523-000091-19	910503705166	523-000092-19	910503705247
eW Cove QLX Powercore 220-240 VAC	High	523-000090-59	910503705126	523-000091-59	910503705207	523-000092-59	910503705287
	Low	523-000090-27	910503705093	523-000091-27	910503705174	523-000092-27	910503705255
eW Cove QLX Powercore 220-240 VAC Fixture and 10 ft (3 m) Leader Cable with terminator	High	523-000090-67	910503705134	523-000091-67	910503705215	523-000092-67	910503705295
	Low	523-000090-35	910503705102	523-000091-35	910503705182	523-000092-35	910503705263
eW Cove QLX Powercore 277 VAC	High	523-000090-75	910503705142	523-000091-75	910503705223	523-000092-75	910503705304
	Low	523-000090-43	910503705110	523-000091-43	910503705190	523-000092-43	910503705271

Use Item Number when ordering in North America.

Ordering Information - 4000 K*, Medium Beam (60° x 90°)



	Power Level	152 mm (6 in)		305 mm (12 in)		1220 mm (48 in)	
		Item Number	Philips 12NC	Item Number	Philips 12NC	Item Number	Philips 12NC
eW Cove QLX Powercore 120 VAC	High	523-000090-55	910503705122	523-000091-55	910503705203	523-000092-55	910503705283
	Low	523-000090-23	910503705089	523-000091-23	910503705170	523-000092-23	910503705251
eW Cove QLX Powercore 220-240 VAC	High	523-000090-63	910503705130	523-000091-63	910503705211	523-000092-63	910503705291
	Low	523-000090-31	910503705097	523-000091-31	910503705178	523-000092-31	910503705259
eW Cove QLX Powercore 220-240 VAC Fixture and 3 m (10 ft) Leader Cable with terminator	High	523-000090-71	910503705138	523-000091-71	910503705219	523-000092-71	910503705299
	Low	523-000090-39	910503705106	523-000091-39	910503705186	523-000092-39	910503705267
eW Cove QLX Powercore 277 VAC	High	523-000090-79	910503705146	523-000091-79	910503705227	523-000092-79	910503705308
	Low	523-000090-47	910503705114	523-000091-47	910503705194	523-000092-47	910503705275

* Color temperatures conform to nominal CCTs as defined in ANSI Chromaticity Standard C78.377A.

Use Item Number when ordering in North America.

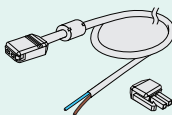
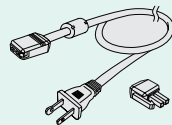

Accessories

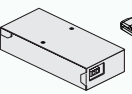
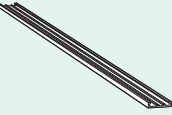
Item	Housing Color	Dimensions	Item Number	Philips 12NC		
Leader Cable (includes terminator), UL / cUL	Black	3 m (10 ft)	108-000032-10	912400130570		For connection to standard junction box
Leader Cable (includes terminator), CE / CCC	Black	3 m (10 ft)	108-000032-11	912400130571		
Leader Cable (includes terminator), UL / cUL	White	3 m (10 ft)	108-000032-12	912400130572		
Leader Cable (includes terminator), CE / CCC	White	3 m (10 ft)	108-000032-13	912400130573		
Leader Cable (includes terminator), UL, US Plug	Black	2.4 m (8 ft)	108-000032-14	912400130574		For portable installations
Jumper Cable, UL / cUL	White	305 mm (1 ft)	108-000033-06	910503700895		Depending on the installation's design, you may need jumper cables to add space between fixtures
		1.5 m (5 ft)	108-000033-07	910503700896		
Jumper Cable, CE / CCC	White	305 mm (1 ft)	108-000033-08	910503700897		
		1.5 m (5 ft)	108-000033-09	910503700898		
Wiring Compartment (includes terminator)	White	2.9 x 6.8 x 16 cm (1.17 x 2.7 x 6.32 in) (H x W x L)	120-000076-01	912400130576		Can be used for direct connection to conduit
Mounting Track	White	1219 mm (4 ft)	120-000125-00	910503701788		Optional mounting track ensures straight runs of fixtures

Use Item Number when ordering in North America.

Compatible Dimmers†

Supplier	Part Number	Description	Voltage
Philips	913701252701	Captivation Phase Dimmer DC-DPD-I-1S-101	120 VAC
Philips	913703021009	DTE310	230 VAC
Philips	912400133633	Data Adapter, DALI to ELV, DigiDim 452	230 VAC
Philips	913701252701	Captivation Phase Dimmer DC-DPD-I-1S-101	277 VAC
Philips Strand	A21 with IGBT module	A21 Dimmer Cabinet with IGBT Dimmer Module	120 VAC
Philips Strand	A21 with IGBT module	A21 Dimmer Cabinet with IGBT Dimmer Module	277 VAC
Lutron	NTELV-600	Nova T Electronic Low Voltage Dimmer	120 VAC
Lutron	PHPM-PA-DV-WH	Phase-Adaptive Power Module	120 VAC
Lutron	PHPM-PA-DV-WH	Phase-Adaptive Power Module	277 VAC

† These dimmers have been tested in our lab and found to be compatible with this product. All installations are different. We highly recommend performing a full mockup of every lighting circuit, including all luminaires and controls, to test for the desired dimming range. Visit <http://1.usa.gov/1g3cGfs> for more information.

Submitted by Bright Focus Sales, Inc.

BRIGHTFOCUS

Job Name:
MARTIN HALL

Catalog Number:

523-000092-51

Notes:

Type:

CV1

CLE15-11619

Copyright © 2015 Philips Solid-State Lighting Solutions, Inc. All rights reserved. Chromacore, Chromasic, CK, the CK logo, Color Kinetics, the Color Kinetics logo, ColorBlast, ColorBlaze, ColorBurst, ColorGraze, ColorPlay, ColorReach, iW Reach, eV Reach, DiMand, EssentialWhite, eV, iColor, iColor Cove, IntelliWhite, iW, iPlayer, Optibin, and Powercore are either registered trademarks or trademarks of Philips Solid-State Lighting Solutions, Inc. in the United States and / or other countries. All other brand or product names are trademarks or registered trademarks of their respective owners. Due to continuous improvements and innovations, specifications may change without notice.

DAS-000068-05 R08 02-15



Philips Color Kinetics
3 Burlington Woods Drive
Burlington, Massachusetts 01803 USA
Tel 888.385.5742
Tel 617.423.9999
Fax 617.423.9998
www.philipscolorkinetics.com
@colorkinetics



Date: _____ Type: _____

Firm Name: _____

Project: _____

eW Cove QLX Powercore

Performance interior linear LED cove and accent fixture with solid white light

Ordering Information

eW Cove QLX Powercore is a dimmable, linear LED fixture that provides an affordable, energy-efficient alternative to traditional cove lighting in applications requiring white light. With its low profile, rotating housing and flexible end-to-end locking power connectors, eW Cove QLX Powercore is the perfect choice for a wide range of interior retail, exhibit, hospitality, and architectural settings.

- Industry-best white-light quality and color consistency — Advances in Optibin, Philips proprietary binning optimization process, now provides color-consistency within a 2-step MacAdam ellipse across eW Cove product fixtures and manufacturing runs.
- Uncompromised Performance — Efficacies of near 100 lm/w provide optimum output without restrictions on lumen maintenance, operating temperature or warranty.
- Multiple options for design flexibility — Available in four color temperatures ranging from a warm 2700 K to a cool 4000 K. Lengths of 152 mm (6 in), 305 mm (12 in), and 1220 mm (48 in), wide and medium beam angles, and two power levels offer further design flexibility.
- Support for multiple voltages — Accepts power input of 120, 220 – 240, or 277 VAC for consistent installation and operation from line voltage in many locations.

Smooth dimming capability — Patented DIMand technology offers smooth dimming capability with selected reverse-phase ELV-type dimmers.

For detailed product information, please refer to the eW Cove QLX Powercore Product Guide at www.philipscolorkinetics.com/ls/essentialwhite/ewcoveqlxpc/

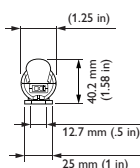

Medium Beam
60° x 90°

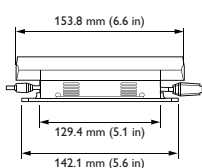

Wide Beam
110° x 110°

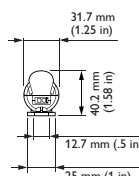

Medium Beam
60° x 90°

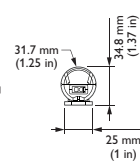
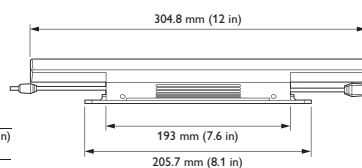

Wide Beam
110° x 110°

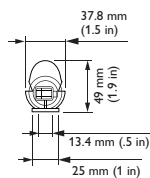

Medium Beam
60° x 90°

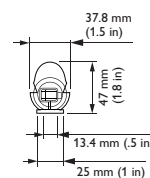
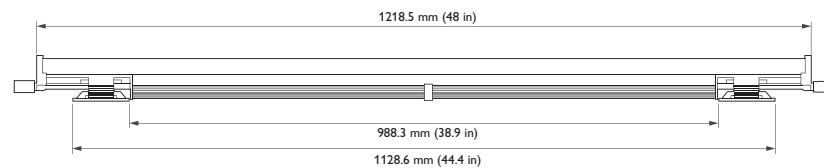

Wide Beam
110° x 110°

Ordering Information - 3500 K*, Wide Beam (110° x 110°)

	Power Level	152 mm (6 in)		305 mm (12 in)		1220 mm (48 in)	
		Item Number	Philips 12NC	Item Number	Philips 12NC	Item Number	Philips 12NC
eW Cove QLX Powercore 120 VAC	High	523-000090-50	910503705117	523-000091-50	910503705197	523-000092-50	910503705278
	Low	523-000090-18	910503705084	523-000091-18	910503705165	523-000092-18	910503705246
eW Cove QLX Powercore 220-240 VAC	High	523-000090-58	910503705125	523-000091-58	910503705206	523-000092-58	910503705286
	Low	523-000090-26	910503705092	523-000091-26	910503705173	523-000092-26	910503705254
eW Cove QLX Powercore 220-240 VAC <i>Fixture and 3 m (10 ft) Leader Cable with terminator</i>	High	523-000090-66	910503705133	523-000091-66	910503705214	523-000092-66	910503705294
	Low	523-000090-34	910503705101	523-000091-34	910503705181	523-000092-34	910503705262
eW Cove QLX Powercore 277 VAC	High	523-000090-74	910503705141	523-000091-74	910503705222	523-000092-74	910503705303
	Low	523-000090-42	910503705109	523-000091-42	910503705189	523-000092-42	910503705270

Use Item Number when ordering in North America.

Ordering Information - 3500 K*, Medium Beam (60° x 90°)

	Power Level	152 mm (6 in)		305 mm (12 in)		1220 mm (48 in)	
		Item Number	Philips 12NC	Item Number	Philips 12NC	Item Number	Philips 12NC
eW Cove QLX Powercore 120 VAC	High	523-000090-54	910503705121	523-000091-54	910503705202	523-000092-54	910503705282
	Low	523-000090-22	910503705088	523-000091-22	910503705169	523-000092-22	910503705250
eW Cove QLX Powercore 220-240 VAC	High	523-000090-62	910503705129	523-000091-62	910503705210	523-000092-62	910503705290
	Low	523-000090-30	910503705096	523-000091-30	910503705177	523-000092-30	910503705258
eW Cove QLX Powercore 220-240 VAC <i>Fixture and 3 m (10 ft) Leader Cable with terminator</i>	High	523-000090-70	910503705137	523-000091-70	910503705218	523-000092-70	910503705298
	Low	523-000090-38	910503705105	523-000091-38	910503705185	523-000092-38	910503705266
eW Cove QLX Powercore 277 VAC	High	523-000090-78	910503705145	523-000091-78	910503705226	523-000092-78	910503705305
	Low	523-000090-46	910503705113	523-000091-46	910503705193	523-000092-46	910503705272

Use Item Number when ordering in North America.

Ordering Information - 4000 K*, Wide Beam (110° x 110°)

	Power Level	152 mm (6 in)		305 mm (12 in)		1220 mm (48 in)	
		Item Number	Philips 12NC	Item Number	Philips 12NC	Item Number	Philips 12NC
eW Cove QLX Powercore 120 VAC	High	523-000090-51	910503705118	523-000091-51	910503705198	523-000092-51	910503705279
	Low	523-000090-19	910503705085	523-000091-19	910503705166	523-000092-19	910503705247
eW Cove QLX Powercore 220-240 VAC	High	523-000090-59	910503705126	523-000091-59	910503705207	523-000092-59	910503705287
	Low	523-000090-27	910503705093	523-000091-27	910503705174	523-000092-27	910503705255
eW Cove QLX Powercore 220-240 VAC <i>Fixture and 10 ft (3 m) Leader Cable with terminator</i>	High	523-000090-67	910503705134	523-000091-67	910503705215	523-000092-67	910503705295
	Low	523-000090-35	910503705102	523-000091-35	910503705182	523-000092-35	910503705263
eW Cove QLX Powercore 277 VAC	High	523-000090-75	910503705142	523-000091-75	910503705223	523-000092-75	910503705304
	Low	523-000090-43	910503705110	523-000091-43	910503705190	523-000092-43	910503705271

Use Item Number when ordering in North America.

Ordering Information - 4000 K*, Medium Beam (60° x 90°)

	Power Level	152 mm (6 in)		305 mm (12 in)		1220 mm (48 in)	
		Item Number	Philips 12NC	Item Number	Philips 12NC	Item Number	Philips 12NC
eW Cove QLX Powercore 120 VAC	High	523-000090-55	910503705122	523-000091-55	910503705203	523-000092-55	910503705283
	Low	523-000090-23	910503705089	523-000091-23	910503705170	523-000092-23	910503705251
eW Cove QLX Powercore 220-240 VAC	High	523-000090-63	910503705130	523-000091-63	910503705211	523-000092-63	910503705291
	Low	523-000090-31	910503705097	523-000091-31	910503705178	523-000092-31	910503705259
eW Cove QLX Powercore 220-240 VAC <i>Fixture and 3 m (10 ft) Leader Cable with terminator</i>	High	523-000090-71	910503705138	523-000091-71	910503705219	523-000092-71	910503705299
	Low	523-000090-39	910503705106	523-000091-39	910503705186	523-000092-39	910503705267
eW Cove QLX Powercore 277 VAC	High	523-000090-79	910503705146	523-000091-79	910503705227	523-000092-79	910503705308
	Low	523-000090-47	910503705114	523-000091-47	910503705194	523-000092-47	910503705275



* Color temperatures conform to nominal CCTs as defined in ANSI Chromaticity Standard C78.377A.

Use Item Number when ordering in North America.

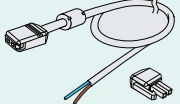
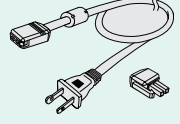

Submitted by Bright Focus Sales, Inc.		Catalog Number: 523-000091-51 / 108-000033-06 / 120 000076-01 / 120-000125-00 Notes:	Type: CV1 CLE15-11619
BRIGHTFOCUS	Job Name: MARTIN HALL		

Accessories

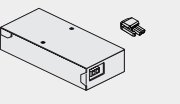
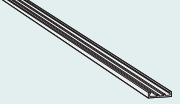
Item	Housing Color	Dimensions	Item Number	Philips 12NC		
Leader Cable (includes terminator), UL / cUL	Black	3 m (10 ft)	108-000032-10	912400130570		For connection to standard junction box
Leader Cable (includes terminator), CE / CCC	Black	3 m (10 ft)	108-000032-11	912400130571		
Leader Cable (includes terminator), UL / cUL	White	3 m (10 ft)	108-000032-12	912400130572		
Leader Cable (includes terminator), CE / CCC	White	3 m (10 ft)	108-000032-13	912400130573		
Leader Cable (includes terminator), UL, US Plug	Black	2.4 m (8 ft)	108-000032-14	912400130574		For portable installations
Jumper Cable, UL / cUL	White	305 mm (1 ft)	108-000033-06	910503700895		Depending on the installation's design, you may need jumper cables to add space between fixtures
		1.5 m (5 ft)	108-000033-07	910503700896		
Jumper Cable, CE / CCC	White	305 mm (1 ft)	108-000033-08	910503700897		
		1.5 m (5 ft)	108-000033-09	910503700898		
Wiring Compartment (includes terminator)	White	2.9 x 6.8 x 16 cm (1.17 x 2.7 x 6.32 in) (H x W x L)	120-000076-01	912400130576		Can be used for direct connection to conduit
Mounting Track	White	1219 mm (4 ft)	120-000125-00	910503701788		Optional mounting track ensures straight runs of fixtures

Use Item Number when ordering in North America.

Compatible Dimmers[†]

Supplier	Part Number	Description	Voltage
Philips	913701252701	Captivation Phase Dimmer DC-DPD-I-1S-101	120 VAC
Philips	913703021009	DTE310	230 VAC
Philips	912400133633	Data Adapter, DALI to ELV, DigiDim 452	230 VAC
Philips	913701252701	Captivation Phase Dimmer DC-DPD-I-1S-101	277 VAC
Philips Strand	A21 with IGBT module	A21 Dimmer Cabinet with IGBT Dimmer Module	120 VAC
Philips Strand	A21 with IGBT module	A21 Dimmer Cabinet with IGBT Dimmer Module	277 VAC
Lutron	NTELV-600	Nova T Electronic Low Voltage Dimmer	120 VAC
Lutron	PHPM-PA-DV-WH	Phase-Adaptive Power Module	120 VAC
Lutron	PHPM-PA-DV-WH	Phase-Adaptive Power Module	277 VAC

[†] These dimmers have been tested in our lab and found to be compatible with this product. All installations are different. We highly recommend performing a full mockup of every lighting circuit, including all luminaires and controls, to test for the desired dimming range. Visit <http://1.usa.gov/1g3cGfs> for more information.

Submitted by Bright Focus Sales, Inc.	Job Name:	Catalog Number:	Type:
BRIGHTFOCUS	MARTIN HALL	523-000091-51 / 108-000033-06 / 120 000076-01 / 120-000125-00 Notes:	CV1 CLE15-11619

Copyright © 2015 Philips Solid-State Lighting Solutions, Inc. All rights reserved. Chromacore, Chromasic, CK, the CK logo, Color Kinetics, the Color Kinetics logo, ColorBlast, ColorBlaze, ColorBurst, ColorGraze, ColorPlay, ColorReach, iW Reach, eV Reach, DiMand, EssentialWhite, eV, iColor, iColor Cove, IntelliWhite, iW, iPlayer, Optibin, and Powercore are either registered trademarks or trademarks of Philips Solid-State Lighting Solutions, Inc. in the United States and / or other countries. All other brand or product names are trademarks or registered trademarks of their respective owners. Due to continuous improvements and innovations, specifications may change without notice.

DAS-000068-05 R08 02-15



Philips Color Kinetics
3 Burlington Woods Drive
Burlington, Massachusetts 01803 USA
Tel 888.385.5742
Tel 617.423.9999
Fax 617.423.9998
www.philipscolorkinetics.com
@colorkinetics



Date: _____ Type: _____

Firm Name: _____

Project: _____

eW Cove QLX Powercore

Performance interior linear LED cove and accent fixture with solid white light

Ordering Information

eW Cove QLX Powercore is a dimmable, linear LED fixture that provides an affordable, energy-efficient alternative to traditional cove lighting in applications requiring white light. With its low profile, rotating housing and flexible end-to-end locking power connectors, eW Cove QLX Powercore is the perfect choice for a wide range of interior retail, exhibit, hospitality, and architectural settings.

- Industry-best white-light quality and color consistency — Advances in Optibin, Philips proprietary binning optimization process, now provides color-consistency within a 2-step MacAdam ellipse across eW Cove product fixtures and manufacturing runs.
- Uncompromised Performance — Efficacies of near 100 lm/w provide optimum output without restrictions on lumen maintenance, operating temperature or warranty.
- Multiple options for design flexibility — Available in four color temperatures ranging from a warm 2700 K to a cool 4000 K. Lengths of 152 mm (6 in), 305 mm (12 in), and 1220 mm (48 in), wide and medium beam angles, and two power levels offer further design flexibility.
- Support for multiple voltages — Accepts power input of 120, 220 – 240, or 277 VAC for consistent installation and operation from line voltage in many locations.

Smooth dimming capability — Patented DIMand technology offers smooth dimming capability with selected reverse-phase ELV-type dimmers.

For detailed product information, please refer to the eW Cove QLX Powercore Product Guide at www.philipscolorkinetics.com/ls/essentialwhite/ewcoveqlxpc/

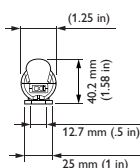

Medium Beam
60° x 90°

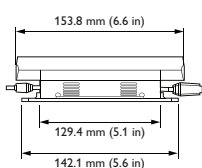

Wide Beam
110° x 110°

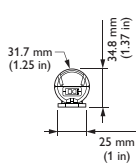

Medium Beam
60° x 90°

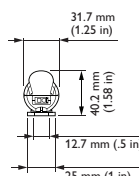

Wide Beam
110° x 110°

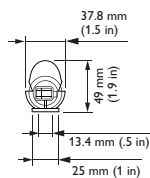
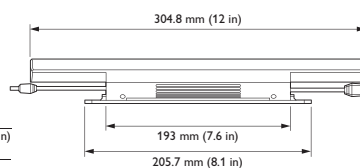

Medium Beam
60° x 90°

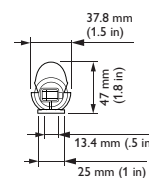
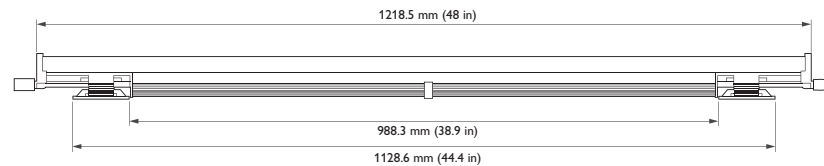

Wide Beam
110° x 110°



Ordering Information - 3500 K*, Wide Beam (110° x 110°)

	Power Level	152 mm (6 in)		305 mm (12 in)		1220 mm (48 in)	
		Item Number	Philips 12NC	Item Number	Philips 12NC	Item Number	Philips 12NC
eW Cove QLX Powercore 120 VAC	High	523-000090-50	910503705117	523-000091-50	910503705197	523-000092-50	910503705278
	Low	523-000090-18	910503705084	523-000091-18	910503705165	523-000092-18	910503705246
eW Cove QLX Powercore 220-240 VAC	High	523-000090-58	910503705125	523-000091-58	910503705206	523-000092-58	910503705286
	Low	523-000090-26	910503705092	523-000091-26	910503705173	523-000092-26	910503705254
eW Cove QLX Powercore 220-240 VAC Fixture and 3 m (10 ft) Leader Cable with terminator	High	523-000090-66	910503705133	523-000091-66	910503705214	523-000092-66	910503705294
	Low	523-000090-34	910503705101	523-000091-34	910503705181	523-000092-34	910503705262
eW Cove QLX Powercore 277 VAC	High	523-000090-74	910503705141	523-000091-74	910503705222	523-000092-74	910503705303
	Low	523-000090-42	910503705109	523-000091-42	910503705189	523-000092-42	910503705270

Use Item Number when ordering in North America.

Ordering Information - 3500 K*, Medium Beam (60° x 90°)

	Power Level	152 mm (6 in)		305 mm (12 in)		1220 mm (48 in)	
		Item Number	Philips 12NC	Item Number	Philips 12NC	Item Number	Philips 12NC
eW Cove QLX Powercore 120 VAC	High	523-000090-54	910503705121	523-000091-54	910503705202	523-000092-54	910503705282
	Low	523-000090-22	910503705088	523-000091-22	910503705169	523-000092-22	910503705250
eW Cove QLX Powercore 220-240 VAC	High	523-000090-62	910503705129	523-000091-62	910503705210	523-000092-62	910503705290
	Low	523-000090-30	910503705096	523-000091-30	910503705177	523-000092-30	910503705258
eW Cove QLX Powercore 220-240 VAC Fixture and 3 m (10 ft) Leader Cable with terminator	High	523-000090-70	910503705137	523-000091-70	910503705218	523-000092-70	910503705298
	Low	523-000090-38	910503705105	523-000091-38	910503705185	523-000092-38	910503705266
eW Cove QLX Powercore 277 VAC	High	523-000090-78	910503705145	523-000091-78	910503705226	523-000092-78	910503705305
	Low	523-000090-46	910503705113	523-000091-46	910503705193	523-000092-46	910503705272

Use Item Number when ordering in North America.

Ordering Information - 4000 K*, Wide Beam (110° x 110°)

	Power Level	152 mm (6 in)		305 mm (12 in)		1220 mm (48 in)	
		Item Number	Philips 12NC	Item Number	Philips 12NC	Item Number	Philips 12NC
eW Cove QLX Powercore 120 VAC	High	523-000090-51	910503705118	523-000091-51	910503705198	523-000092-51	910503705279
	Low	523-000090-19	910503705085	523-000091-19	910503705166	523-000092-19	910503705247
eW Cove QLX Powercore 220-240 VAC	High	523-000090-59	910503705126	523-000091-59	910503705207	523-000092-59	910503705287
	Low	523-000090-27	910503705093	523-000091-27	910503705174	523-000092-27	910503705255
eW Cove QLX Powercore 220-240 VAC Fixture and 10 ft (3 m) Leader Cable with terminator	High	523-000090-67	910503705134	523-000091-67	910503705215	523-000092-67	910503705295
	Low	523-000090-35	910503705102	523-000091-35	910503705182	523-000092-35	910503705263
eW Cove QLX Powercore 277 VAC	High	523-000090-75	910503705142	523-000091-75	910503705223	523-000092-75	910503705304
	Low	523-000090-43	910503705110	523-000091-43	910503705190	523-000092-43	910503705271

Use Item Number when ordering in North America.

Ordering Information - 4000 K*, Medium Beam (60° x 90°)



	Power Level	152 mm (6 in)		305 mm (12 in)		1220 mm (48 in)	
		Item Number	Philips 12NC	Item Number	Philips 12NC	Item Number	Philips 12NC
eW Cove QLX Powercore 120 VAC	High	523-000090-55	910503705122	523-000091-55	910503705203	523-000092-55	910503705283
	Low	523-000090-23	910503705089	523-000091-23	910503705170	523-000092-23	910503705251
eW Cove QLX Powercore 220-240 VAC	High	523-000090-63	910503705130	523-000091-63	910503705211	523-000092-63	910503705291
	Low	523-000090-31	910503705097	523-000091-31	910503705178	523-000092-31	910503705259
eW Cove QLX Powercore 220-240 VAC Fixture and 3 m (10 ft) Leader Cable with terminator	High	523-000090-71	910503705138	523-000091-71	910503705219	523-000092-71	910503705299
	Low	523-000090-39	910503705106	523-000091-39	910503705186	523-000092-39	910503705267
eW Cove QLX Powercore 277 VAC	High	523-000090-79	910503705146	523-000091-79	910503705227	523-000092-79	910503705308
	Low	523-000090-47	910503705114	523-000091-47	910503705194	523-000092-47	910503705275

* Color temperatures conform to nominal CCTs as defined in ANSI Chromaticity Standard C78.377A.

Use Item Number when ordering in North America.

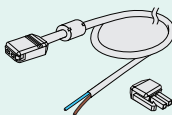
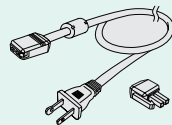

Accessories

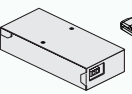
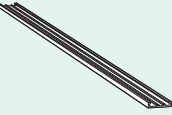
Item	Housing Color	Dimensions	Item Number	Philips 12NC		
Leader Cable (includes terminator), UL / cUL	Black	3 m (10 ft)	108-000032-10	912400130570		For connection to standard junction box
Leader Cable (includes terminator), CE / CCC	Black	3 m (10 ft)	108-000032-11	912400130571		
Leader Cable (includes terminator), UL / cUL	White	3 m (10 ft)	108-000032-12	912400130572		
Leader Cable (includes terminator), CE / CCC	White	3 m (10 ft)	108-000032-13	912400130573		
Leader Cable (includes terminator), UL, US Plug	Black	2.4 m (8 ft)	108-000032-14	912400130574		For portable installations
Jumper Cable, UL / cUL	White	305 mm (1 ft)	108-000033-06	910503700895		Depending on the installation's design, you may need jumper cables to add space between fixtures
		1.5 m (5 ft)	108-000033-07	910503700896		
Jumper Cable, CE / CCC	White	305 mm (1 ft)	108-000033-08	910503700897		
		1.5 m (5 ft)	108-000033-09	910503700898		
Wiring Compartment (includes terminator)	White	2.9 x 6.8 x 16 cm (1.17 x 2.7 x 6.32 in) (H x W x L)	120-000076-01	912400130576		Can be used for direct connection to conduit
Mounting Track	White	1219 mm (4 ft)	120-000125-00	910503701788		Optional mounting track ensures straight runs of fixtures

Use Item Number when ordering in North America.

Compatible Dimmers†

Supplier	Part Number	Description	Voltage
Philips	913701252701	Captivation Phase Dimmer DC-DPD-I-1S-101	120 VAC
Philips	913703021009	DTE310	230 VAC
Philips	912400133633	Data Adapter, DALI to ELV, DigiDim 452	230 VAC
Philips	913701252701	Captivation Phase Dimmer DC-DPD-I-1S-101	277 VAC
Philips Strand	A21 with IGBT module	A21 Dimmer Cabinet with IGBT Dimmer Module	120 VAC
Philips Strand	A21 with IGBT module	A21 Dimmer Cabinet with IGBT Dimmer Module	277 VAC
Lutron	NTELV-600	Nova T Electronic Low Voltage Dimmer	120 VAC
Lutron	PHPM-PA-DV-WH	Phase-Adaptive Power Module	120 VAC
Lutron	PHPM-PA-DV-WH	Phase-Adaptive Power Module	277 VAC

† These dimmers have been tested in our lab and found to be compatible with this product. All installations are different. We highly recommend performing a full mockup of every lighting circuit, including all luminaires and controls, to test for the desired dimming range. Visit <http://1.usa.gov/1g3cGfs> for more information.

Submitted by Bright Focus Sales, Inc.

BRIGHTFOCUS

Job Name:
MARTIN HALL

Catalog Number:

523-000092-51

Notes:

Type:

CV1

CLE15-11619

Copyright © 2015 Philips Solid-State Lighting Solutions, Inc. All rights reserved. Chromacore, Chromasic, CK, the CK logo, Color Kinetics, the Color Kinetics logo, ColorBlast, ColorBlaze, ColorBurst, ColorGraze, ColorPlay, ColorReach, iW Reach, eV Reach, DiMand, EssentialWhite, eV, iColor, iColor Cove, IntelliWhite, iW, iPlayer, Optibin, and Powercore are either registered trademarks or trademarks of Philips Solid-State Lighting Solutions, Inc. in the United States and / or other countries. All other brand or product names are trademarks or registered trademarks of their respective owners. Due to continuous improvements and innovations, specifications may change without notice.

DAS-000068-05 R08 02-15



Philips Color Kinetics
3 Burlington Woods Drive
Burlington, Massachusetts 01803 USA
Tel 888.385.5742
Tel 617.423.9999
Fax 617.423.9998
www.philipscolorkinetics.com
@colorkinetics



Date: _____ Type: _____

Firm Name: _____

Project: _____

eW Cove QLX Powercore

Performance interior linear LED cove and accent fixture with solid white light

Ordering Information

eW Cove QLX Powercore is a dimmable, linear LED fixture that provides an affordable, energy-efficient alternative to traditional cove lighting in applications requiring white light. With its low profile, rotating housing and flexible end-to-end locking power connectors, eW Cove QLX Powercore is the perfect choice for a wide range of interior retail, exhibit, hospitality, and architectural settings.

- Industry-best white-light quality and color consistency — Advances in Optibin, Philips proprietary binning optimization process, now provides color-consistency within a 2-step MacAdam ellipse across eW Cove product fixtures and manufacturing runs.
- Uncompromised Performance — Efficacies of near 100 lm/w provide optimum output without restrictions on lumen maintenance, operating temperature or warranty.
- Multiple options for design flexibility — Available in four color temperatures ranging from a warm 2700 K to a cool 4000 K. Lengths of 152 mm (6 in), 305 mm (12 in), and 1220 mm (48 in), wide and medium beam angles, and two power levels offer further design flexibility.
- Support for multiple voltages — Accepts power input of 120, 220 – 240, or 277 VAC for consistent installation and operation from line voltage in many locations.

Smooth dimming capability — Patented DIMand technology offers smooth dimming capability with selected reverse-phase ELV-type dimmers.

For detailed product information, please refer to the eW Cove QLX Powercore Product Guide at www.philipscolorkinetics.com/ls/essentialwhite/ewcoveqlxpc/

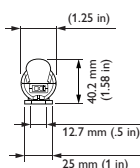

Medium Beam
60° x 90°

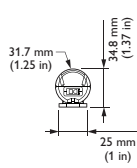
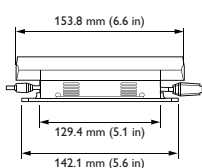

Wide Beam
110° x 110°

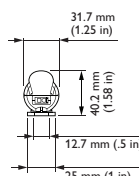

Medium Beam
60° x 90°

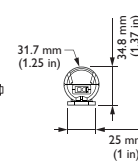
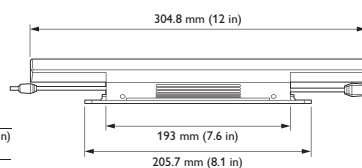

Wide Beam
110° x 110°

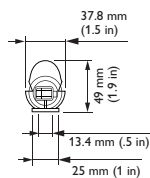

Medium Beam
60° x 90°

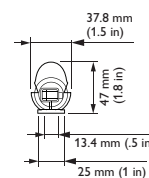
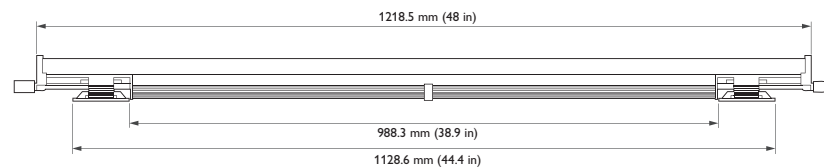

Wide Beam
110° x 110°

Ordering Information - 3500 K*, Wide Beam (110° x 110°)

	Power Level	152 mm (6 in)		305 mm (12 in)		1220 mm (48 in)	
		Item Number	Philips 12NC	Item Number	Philips 12NC	Item Number	Philips 12NC
eW Cove QLX Powercore 120 VAC	High	523-000090-50	910503705117	523-000091-50	910503705197	523-000092-50	910503705278
	Low	523-000090-18	910503705084	523-000091-18	910503705165	523-000092-18	910503705246
eW Cove QLX Powercore 220-240 VAC	High	523-000090-58	910503705125	523-000091-58	910503705206	523-000092-58	910503705286
	Low	523-000090-26	910503705092	523-000091-26	910503705173	523-000092-26	910503705254
eW Cove QLX Powercore 220-240 VAC <i>Fixture and 3 m (10 ft) Leader Cable with terminator</i>	High	523-000090-66	910503705133	523-000091-66	910503705214	523-000092-66	910503705294
	Low	523-000090-34	910503705101	523-000091-34	910503705181	523-000092-34	910503705262
eW Cove QLX Powercore 277 VAC	High	523-000090-74	910503705141	523-000091-74	910503705222	523-000092-74	910503705303
	Low	523-000090-42	910503705109	523-000091-42	910503705189	523-000092-42	910503705270

Use Item Number when ordering in North America.

Ordering Information - 3500 K*, Medium Beam (60° x 90°)

	Power Level	152 mm (6 in)		305 mm (12 in)		1220 mm (48 in)	
		Item Number	Philips 12NC	Item Number	Philips 12NC	Item Number	Philips 12NC
eW Cove QLX Powercore 120 VAC	High	523-000090-54	910503705121	523-000091-54	910503705202	523-000092-54	910503705282
	Low	523-000090-22	910503705088	523-000091-22	910503705169	523-000092-22	910503705250
eW Cove QLX Powercore 220-240 VAC	High	523-000090-62	910503705129	523-000091-62	910503705210	523-000092-62	910503705290
	Low	523-000090-30	910503705096	523-000091-30	910503705177	523-000092-30	910503705258
eW Cove QLX Powercore 220-240 VAC <i>Fixture and 3 m (10 ft) Leader Cable with terminator</i>	High	523-000090-70	910503705137	523-000091-70	910503705218	523-000092-70	910503705298
	Low	523-000090-38	910503705105	523-000091-38	910503705185	523-000092-38	910503705266
eW Cove QLX Powercore 277 VAC	High	523-000090-78	910503705145	523-000091-78	910503705226	523-000092-78	910503705305
	Low	523-000090-46	910503705113	523-000091-46	910503705193	523-000092-46	910503705272

Use Item Number when ordering in North America.

Ordering Information - 4000 K*, Wide Beam (110° x 110°)

	Power Level	152 mm (6 in)		305 mm (12 in)		1220 mm (48 in)	
		Item Number	Philips 12NC	Item Number	Philips 12NC	Item Number	Philips 12NC
eW Cove QLX Powercore 120 VAC	High	523-000090-51	910503705118	523-000091-51	910503705198	523-000092-51	910503705279
	Low	523-000090-19	910503705085	523-000091-19	910503705166	523-000092-19	910503705247
eW Cove QLX Powercore 220-240 VAC	High	523-000090-59	910503705126	523-000091-59	910503705207	523-000092-59	910503705287
	Low	523-000090-27	910503705093	523-000091-27	910503705174	523-000092-27	910503705255
eW Cove QLX Powercore 220-240 VAC <i>Fixture and 10 ft (3 m) Leader Cable with terminator</i>	High	523-000090-67	910503705134	523-000091-67	910503705215	523-000092-67	910503705295
	Low	523-000090-35	910503705102	523-000091-35	910503705182	523-000092-35	910503705263
eW Cove QLX Powercore 277 VAC	High	523-000090-75	910503705142	523-000091-75	910503705223	523-000092-75	910503705304
	Low	523-000090-43	910503705110	523-000091-43	910503705190	523-000092-43	910503705271

Use Item Number when ordering in North America.

Ordering Information - 4000 K*, Medium Beam (60° x 90°)

	Power Level	152 mm (6 in)		305 mm (12 in)		1220 mm (48 in)	
		Item Number	Philips 12NC	Item Number	Philips 12NC	Item Number	Philips 12NC
eW Cove QLX Powercore 120 VAC	High	523-000090-55	910503705122	523-000091-55	910503705203	523-000092-55	910503705283
	Low	523-000090-23	910503705089	523-000091-23	910503705170	523-000092-23	910503705251
eW Cove QLX Powercore 220-240 VAC	High	523-000090-63	910503705130	523-000091-63	910503705211	523-000092-63	910503705291
	Low	523-000090-31	910503705097	523-000091-31	910503705178	523-000092-31	910503705259
eW Cove QLX Powercore 220-240 VAC <i>Fixture and 3 m (10 ft) Leader Cable with terminator</i>	High	523-000090-71	910503705138	523-000091-71	910503705219	523-000092-71	910503705299
	Low	523-000090-39	910503705106	523-000091-39	910503705186	523-000092-39	910503705267
eW Cove QLX Powercore 277 VAC	High	523-000090-79	910503705146	523-000091-79	910503705227	523-000092-79	910503705308
	Low	523-000090-47	910503705114	523-000091-47	910503705194	523-000092-47	910503705275



* Color temperatures conform to nominal CCTs as defined in ANSI Chromaticity Standard C78.377A.

Use Item Number when ordering in North America.

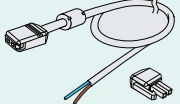
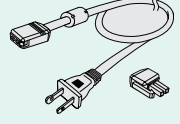

Submitted by Bright Focus Sales, Inc.		Catalog Number: 523-000091-51 / 108-000033-06 / 120 000076-01 / 120-000125-00 Notes:	Type: CV1 CLE15-11619
BRIGHTFOCUS	Job Name: MARTIN HALL		

Accessories

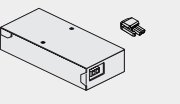
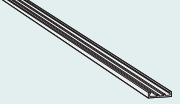
Item	Housing Color	Dimensions	Item Number	Philips 12NC		
Leader Cable (includes terminator), UL / cUL	Black	3 m (10 ft)	108-000032-10	912400130570		For connection to standard junction box
Leader Cable (includes terminator), CE / CCC	Black	3 m (10 ft)	108-000032-11	912400130571		
Leader Cable (includes terminator), UL / cUL	White	3 m (10 ft)	108-000032-12	912400130572		
Leader Cable (includes terminator), CE / CCC	White	3 m (10 ft)	108-000032-13	912400130573		
Leader Cable (includes terminator), UL, US Plug	Black	2.4 m (8 ft)	108-000032-14	912400130574		For portable installations
Jumper Cable, UL / cUL	White	305 mm (1 ft)	108-000033-06	910503700895		Depending on the installation's design, you may need jumper cables to add space between fixtures
		1.5 m (5 ft)	108-000033-07	910503700896		
Jumper Cable, CE / CCC	White	305 mm (1 ft)	108-000033-08	910503700897		
		1.5 m (5 ft)	108-000033-09	910503700898		
Wiring Compartment (includes terminator)	White	2.9 x 6.8 x 16 cm (1.17 x 2.7 x 6.32 in) (H x W x L)	120-000076-01	912400130576		Can be used for direct connection to conduit
Mounting Track	White	1219 mm (4 ft)	120-000125-00	910503701788		Optional mounting track ensures straight runs of fixtures

Use Item Number when ordering in North America.

Compatible Dimmers†

Supplier	Part Number	Description	Voltage
Philips	913701252701	Captivation Phase Dimmer DC-DPD-I-1S-101	120 VAC
Philips	913703021009	DTE310	230 VAC
Philips	912400133633	Data Adapter, DALI to ELV, DigiDim 452	230 VAC
Philips	913701252701	Captivation Phase Dimmer DC-DPD-I-1S-101	277 VAC
Philips Strand	A21 with IGBT module	A21 Dimmer Cabinet with IGBT Dimmer Module	120 VAC
Philips Strand	A21 with IGBT module	A21 Dimmer Cabinet with IGBT Dimmer Module	277 VAC
Lutron	NTELV-600	Nova T Electronic Low Voltage Dimmer	120 VAC
Lutron	PHPM-PA-DV-WH	Phase-Adaptive Power Module	120 VAC
Lutron	PHPM-PA-DV-WH	Phase-Adaptive Power Module	277 VAC

† These dimmers have been tested in our lab and found to be compatible with this product. All installations are different. We highly recommend performing a full mockup of every lighting circuit, including all luminaires and controls, to test for the desired dimming range. Visit <http://1.usa.gov/1g3cGfs> for more information.

Submitted by Bright Focus Sales, Inc.	Job Name: MARTIN HALL	Catalog Number: 523-000091-51 / 108-000033-06 / 120 000076-01 / 120-000125-00	Type: CV1
BRIGHTFOCUS		Notes:	CLE15-11619

Copyright © 2015 Philips Solid-State Lighting Solutions, Inc. All rights reserved. Chromacore, Chromasic, CK, the CK logo, Color Kinetics, the Color Kinetics logo, ColorBlast, ColorBlaze, ColorBurst, ColorGraze, ColorPlay, ColorReach, iW Reach, eV Reach, DiMand, EssentialWhite, eV, iColor, iColor Cove, IntelliWhite, iW, iPlayer, Optibin, and Powercore are either registered trademarks or trademarks of Philips Solid-State Lighting Solutions, Inc. in the United States and / or other countries. All other brand or product names are trademarks or registered trademarks of their respective owners. Due to continuous improvements and innovations, specifications may change without notice.

DAS-000068-05 R08 02-15



Philips Color Kinetics
 3 Burlington Woods Drive
 Burlington, Massachusetts 01803 USA
 Tel 888.385.5742
 Tel 617.423.9999
 Fax 617.423.9998
www.philipscolorkinetics.com
 @colorkinetics



Date: _____ Type: _____

Firm Name: _____

Project: _____

eW Cove QLX Powercore

Performance interior linear LED cove and accent fixture with solid white light

Ordering Information

eW Cove QLX Powercore is a dimmable, linear LED fixture that provides an affordable, energy-efficient alternative to traditional cove lighting in applications requiring white light. With its low profile, rotating housing and flexible end-to-end locking power connectors, eW Cove QLX Powercore is the perfect choice for a wide range of interior retail, exhibit, hospitality, and architectural settings.

- Industry-best white-light quality and color consistency — Advances in Optibin, Philips proprietary binning optimization process, now provides color-consistency within a 2-step MacAdam ellipse across eW Cove product fixtures and manufacturing runs.
- Uncompromised Performance — Efficacies of near 100 lm/w provide optimum output without restrictions on lumen maintenance, operating temperature or warranty.
- Multiple options for design flexibility — Available in four color temperatures ranging from a warm 2700 K to a cool 4000 K. Lengths of 152 mm (6 in), 305 mm (12 in), and 1220 mm (48 in), wide and medium beam angles, and two power levels offer further design flexibility.
- Support for multiple voltages — Accepts power input of 120, 220 – 240, or 277 VAC for consistent installation and operation from line voltage in many locations.

Smooth dimming capability — Patented DIMand technology offers smooth dimming capability with selected reverse-phase ELV-type dimmers.

For detailed product information, please refer to the eW Cove QLX Powercore Product Guide at www.philipscolorkinetics.com/ls/essentialwhite/ewcoveqlxpc/

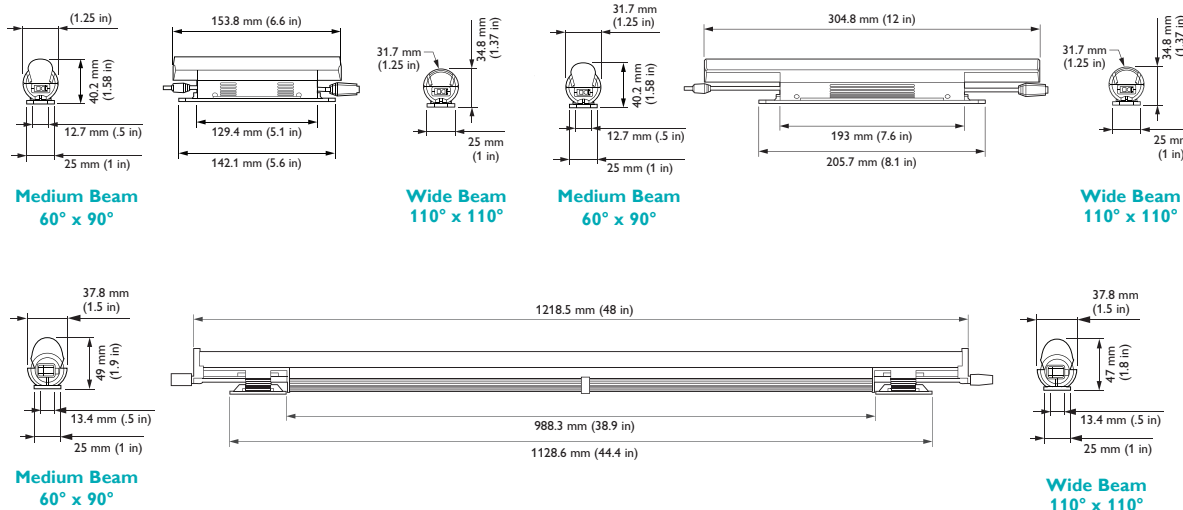

Ordering Information - 3500 K*, Wide Beam (110° x 110°)

	Power Level	152 mm (6 in)		305 mm (12 in)		1220 mm (48 in)	
		Item Number	Philips 12NC	Item Number	Philips 12NC	Item Number	Philips 12NC
eW Cove QLX Powercore 120 VAC	High	523-000090-50	910503705117	523-000091-50	910503705197	523-000092-50	910503705278
	Low	523-000090-18	910503705084	523-000091-18	910503705165	523-000092-18	910503705246
eW Cove QLX Powercore 220-240 VAC	High	523-000090-58	910503705125	523-000091-58	910503705206	523-000092-58	910503705286
	Low	523-000090-26	910503705092	523-000091-26	910503705173	523-000092-26	910503705254
eW Cove QLX Powercore 220-240 VAC Fixture and 3 m (10 ft) Leader Cable with terminator	High	523-000090-66	910503705133	523-000091-66	910503705214	523-000092-66	910503705294
	Low	523-000090-34	910503705101	523-000091-34	910503705181	523-000092-34	910503705262
eW Cove QLX Powercore 277 VAC	High	523-000090-74	910503705141	523-000091-74	910503705222	523-000092-74	910503705303
	Low	523-000090-42	910503705109	523-000091-42	910503705189	523-000092-42	910503705270

Use Item Number when ordering in North America.

Ordering Information - 3500 K*, Medium Beam (60° x 90°)

	Power Level	152 mm (6 in)		305 mm (12 in)		1220 mm (48 in)	
		Item Number	Philips 12NC	Item Number	Philips 12NC	Item Number	Philips 12NC
eW Cove QLX Powercore 120 VAC	High	523-000090-54	910503705121	523-000091-54	910503705202	523-000092-54	910503705282
	Low	523-000090-22	910503705088	523-000091-22	910503705169	523-000092-22	910503705250
eW Cove QLX Powercore 220-240 VAC	High	523-000090-62	910503705129	523-000091-62	910503705210	523-000092-62	910503705290
	Low	523-000090-30	910503705096	523-000091-30	910503705177	523-000092-30	910503705258
eW Cove QLX Powercore 220-240 VAC Fixture and 3 m (10 ft) Leader Cable with terminator	High	523-000090-70	910503705137	523-000091-70	910503705218	523-000092-70	910503705298
	Low	523-000090-38	910503705105	523-000091-38	910503705185	523-000092-38	910503705266
eW Cove QLX Powercore 277 VAC	High	523-000090-78	910503705145	523-000091-78	910503705226	523-000092-78	910503705305
	Low	523-000090-46	910503705113	523-000091-46	910503705193	523-000092-46	910503705272

Use Item Number when ordering in North America.

Ordering Information - 4000 K*, Wide Beam (110° x 110°)

	Power Level	152 mm (6 in)		305 mm (12 in)		1220 mm (48 in)	
		Item Number	Philips 12NC	Item Number	Philips 12NC	Item Number	Philips 12NC
eW Cove QLX Powercore 120 VAC	High	523-000090-51	910503705118	523-000091-51	910503705198	523-000092-51	910503705279
	Low	523-000090-19	910503705085	523-000091-19	910503705166	523-000092-19	910503705247
eW Cove QLX Powercore 220-240 VAC	High	523-000090-59	910503705126	523-000091-59	910503705207	523-000092-59	910503705287
	Low	523-000090-27	910503705093	523-000091-27	910503705174	523-000092-27	910503705255
eW Cove QLX Powercore 220-240 VAC Fixture and 10 ft (3 m) Leader Cable with terminator	High	523-000090-67	910503705134	523-000091-67	910503705215	523-000092-67	910503705295
	Low	523-000090-35	910503705102	523-000091-35	910503705182	523-000092-35	910503705263
eW Cove QLX Powercore 277 VAC	High	523-000090-75	910503705142	523-000091-75	910503705223	523-000092-75	910503705304
	Low	523-000090-43	910503705110	523-000091-43	910503705190	523-000092-43	910503705271

Use Item Number when ordering in North America.

Ordering Information - 4000 K*, Medium Beam (60° x 90°)

	Power Level	152 mm (6 in)		305 mm (12 in)		1220 mm (48 in)	
		Item Number	Philips 12NC	Item Number	Philips 12NC	Item Number	Philips 12NC
eW Cove QLX Powercore 120 VAC	High	523-000090-55	910503705122	523-000091-55	910503705203	523-000092-55	910503705283
	Low	523-000090-23	910503705089	523-000091-23	910503705170	523-000092-23	910503705251
eW Cove QLX Powercore 220-240 VAC	High	523-000090-63	910503705130	523-000091-63	910503705211	523-000092-63	910503705291
	Low	523-000090-31	910503705097	523-000091-31	910503705178	523-000092-31	910503705259
eW Cove QLX Powercore 220-240 VAC Fixture and 3 m (10 ft) Leader Cable with terminator	High	523-000090-71	910503705138	523-000091-71	910503705219	523-000092-71	910503705299
	Low	523-000090-39	910503705106	523-000091-39	910503705186	523-000092-39	910503705267
eW Cove QLX Powercore 277 VAC	High	523-000090-79	910503705146	523-000091-79	910503705227	523-000092-79	910503705308
	Low	523-000090-47	910503705114	523-000091-47	910503705194	523-000092-47	910503705275



* Color temperatures conform to nominal CCTs as defined in ANSI Chromaticity Standard C78.377A.

Use Item Number when ordering in North America.

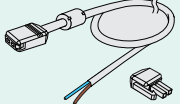
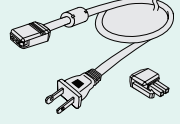

Submitted by Bright Focus Sales, Inc.		Catalog Number: 523-000092-51 / 108-000033-06 / 120 000076-01 / 120-000125-00 Notes:	Type: CV1 CLE15-11619
BRIGHTFOCUS	Job Name: MARTIN HALL		

Accessories

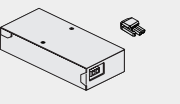
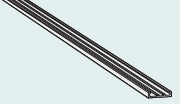
Item	Housing Color	Dimensions	Item Number	Philips 12NC		
Leader Cable (includes terminator), UL / cUL	Black	3 m (10 ft)	108-000032-10	912400130570		For connection to standard junction box
Leader Cable (includes terminator), CE / CCC	Black	3 m (10 ft)	108-000032-11	912400130571		
Leader Cable (includes terminator), UL / cUL	White	3 m (10 ft)	108-000032-12	912400130572		
Leader Cable (includes terminator), CE / CCC	White	3 m (10 ft)	108-000032-13	912400130573		
Leader Cable (includes terminator), UL, US Plug	Black	2.4 m (8 ft)	108-000032-14	912400130574		For portable installations
Jumper Cable, UL / cUL	White	305 mm (1 ft)	108-000033-06	910503700895		Depending on the installation's design, you may need jumper cables to add space between fixtures
		1.5 m (5 ft)	108-000033-07	910503700896		
Jumper Cable, CE / CCC	White	305 mm (1 ft)	108-000033-08	910503700897		
		1.5 m (5 ft)	108-000033-09	910503700898		
Wiring Compartment (includes terminator)	White	2.9 x 6.8 x 16 cm (1.17 x 2.7 x 6.32 in) (H x W x L)	120-000076-01	912400130576		Can be used for direct connection to conduit
Mounting Track	White	1219 mm (4 ft)	120-000125-00	910503701788		Optional mounting track ensures straight runs of fixtures

Use Item Number when ordering in North America.

Compatible Dimmers[†]

Supplier	Part Number	Description	Voltage
Philips	913701252701	Captivation Phase Dimmer DC-DPD-I-1S-101	120 VAC
Philips	913703021009	DTE310	230 VAC
Philips	912400133633	Data Adapter, DALI to ELV, DigiDim 452	230 VAC
Philips	913701252701	Captivation Phase Dimmer DC-DPD-I-1S-101	277 VAC
Philips Strand	A21 with IGBT module	A21 Dimmer Cabinet with IGBT Dimmer Module	120 VAC
Philips Strand	A21 with IGBT module	A21 Dimmer Cabinet with IGBT Dimmer Module	277 VAC
Lutron	NTELV-600	Nova T Electronic Low Voltage Dimmer	120 VAC
Lutron	PHPM-PA-DV-WH	Phase-Adaptive Power Module	120 VAC
Lutron	PHPM-PA-DV-WH	Phase-Adaptive Power Module	277 VAC

[†] These dimmers have been tested in our lab and found to be compatible with this product. All installations are different. We highly recommend performing a full mockup of every lighting circuit, including all luminaires and controls, to test for the desired dimming range. Visit <http://1.usa.gov/1g3cGfs> for more information.

Submitted by Bright Focus Sales, Inc.	Job Name: MARTIN HALL	Catalog Number: 523-000092-51 / 108-000033-06 / 120 000076-01 / 120-000125-00	Type: CV1
BRIGHTFOCUS		Notes:	CLE15-11619

Copyright © 2015 Philips Solid-State Lighting Solutions, Inc. All rights reserved. Chromacore, Chromasic, CK, the CK logo, Color Kinetics, the Color Kinetics logo, ColorBlast, ColorBlaze, ColorBurst, ColorGraze, ColorPlay, ColorReach, iW Reach, eV Reach, DiMand, EssentialWhite, eV, iColor, iColor Cove, IntelliWhite, iW, iPlayer, Optibin, and Powercore are either registered trademarks or trademarks of Philips Solid-State Lighting Solutions, Inc. in the United States and / or other countries. All other brand or product names are trademarks or registered trademarks of their respective owners. Due to continuous improvements and innovations, specifications may change without notice.

DAS-000068-05 R08 02-15



Philips Color Kinetics
 3 Burlington Woods Drive
 Burlington, Massachusetts 01803 USA
 Tel 888.385.5742
 Tel 617.423.9999
 Fax 617.423.9998
www.philipscolorkinetics.com
 @colorkinetics



Date: _____ Type: _____

Firm Name: _____

Project: _____

eW Cove QLX Powercore

Performance interior linear LED cove and accent fixture with solid white light

Ordering Information

eW Cove QLX Powercore is a dimmable, linear LED fixture that provides an affordable, energy-efficient alternative to traditional cove lighting in applications requiring white light. With its low profile, rotating housing and flexible end-to-end locking power connectors, eW Cove QLX Powercore is the perfect choice for a wide range of interior retail, exhibit, hospitality, and architectural settings.

- Industry-best white-light quality and color consistency — Advances in Optibin, Philips proprietary binning optimization process, now provides color-consistency within a 2-step MacAdam ellipse across eW Cove product fixtures and manufacturing runs.
- Uncompromised Performance — Efficacies of near 100 lm/w provide optimum output without restrictions on lumen maintenance, operating temperature or warranty.
- Multiple options for design flexibility — Available in four color temperatures ranging from a warm 2700 K to a cool 4000 K. Lengths of 152 mm (6 in), 305 mm (12 in), and 1220 mm (48 in), wide and medium beam angles, and two power levels offer further design flexibility.
- Support for multiple voltages — Accepts power input of 120, 220 – 240, or 277 VAC for consistent installation and operation from line voltage in many locations.

Smooth dimming capability — Patented DIMand technology offers smooth dimming capability with selected reverse-phase ELV-type dimmers.

For detailed product information, please refer to the eW Cove QLX Powercore Product Guide at www.philipscolorkinetics.com/ls/essentialwhite/ewcoveqlxpc/

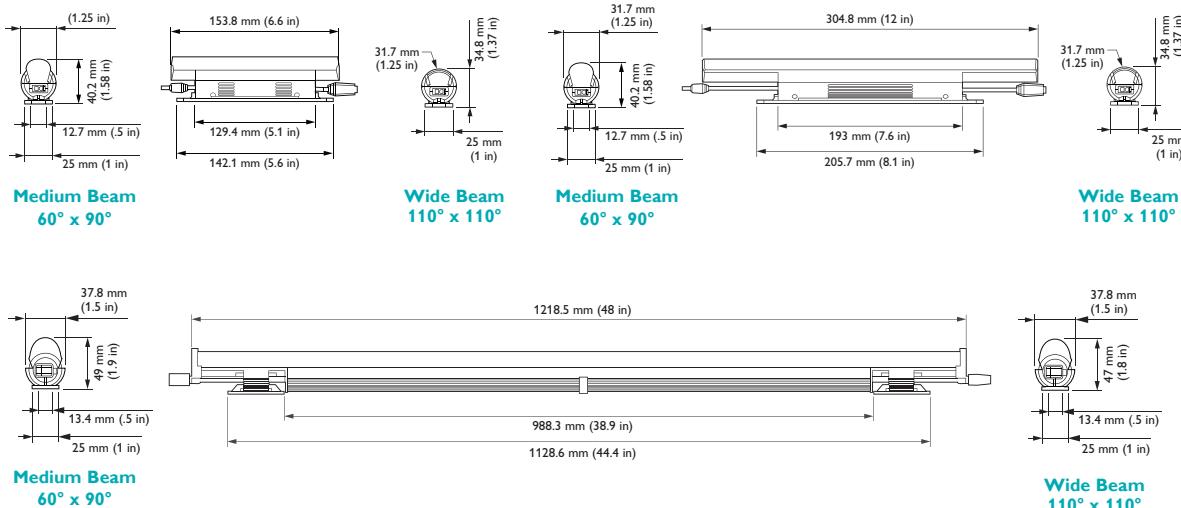

Ordering Information - 3500 K*, Wide Beam (110° x 110°)

	Power Level	152 mm (6 in)		305 mm (12 in)		1220 mm (48 in)	
		Item Number	Philips 12NC	Item Number	Philips 12NC	Item Number	Philips 12NC
eW Cove QLX Powercore 120 VAC	High	523-000090-50	910503705117	523-000091-50	910503705197	523-000092-50	910503705278
	Low	523-000090-18	910503705084	523-000091-18	910503705165	523-000092-18	910503705246
eW Cove QLX Powercore 220-240 VAC	High	523-000090-58	910503705125	523-000091-58	910503705206	523-000092-58	910503705286
	Low	523-000090-26	910503705092	523-000091-26	910503705173	523-000092-26	910503705254
eW Cove QLX Powercore 220-240 VAC Fixture and 3 m (10 ft) Leader Cable with terminator	High	523-000090-66	910503705133	523-000091-66	910503705214	523-000092-66	910503705294
	Low	523-000090-34	910503705101	523-000091-34	910503705181	523-000092-34	910503705262
eW Cove QLX Powercore 277 VAC	High	523-000090-74	910503705141	523-000091-74	910503705222	523-000092-74	910503705303
	Low	523-000090-42	910503705109	523-000091-42	910503705189	523-000092-42	910503705270

Use Item Number when ordering in North America.

Ordering Information - 3500 K*, Medium Beam (60° x 90°)

	Power Level	152 mm (6 in)		305 mm (12 in)		1220 mm (48 in)	
		Item Number	Philips 12NC	Item Number	Philips 12NC	Item Number	Philips 12NC
eW Cove QLX Powercore 120 VAC	High	523-000090-54	910503705121	523-000091-54	910503705202	523-000092-54	910503705282
	Low	523-000090-22	910503705088	523-000091-22	910503705169	523-000092-22	910503705250
eW Cove QLX Powercore 220-240 VAC	High	523-000090-62	910503705129	523-000091-62	910503705210	523-000092-62	910503705290
	Low	523-000090-30	910503705096	523-000091-30	910503705177	523-000092-30	910503705258
eW Cove QLX Powercore 220-240 VAC Fixture and 3 m (10 ft) Leader Cable with terminator	High	523-000090-70	910503705137	523-000091-70	910503705218	523-000092-70	910503705298
	Low	523-000090-38	910503705105	523-000091-38	910503705185	523-000092-38	910503705266
eW Cove QLX Powercore 277 VAC	High	523-000090-78	910503705145	523-000091-78	910503705226	523-000092-78	910503705305
	Low	523-000090-46	910503705113	523-000091-46	910503705193	523-000092-46	910503705272

Use Item Number when ordering in North America.

Ordering Information - 4000 K*, Wide Beam (110° x 110°)

	Power Level	152 mm (6 in)		305 mm (12 in)		1220 mm (48 in)	
		Item Number	Philips 12NC	Item Number	Philips 12NC	Item Number	Philips 12NC
eW Cove QLX Powercore 120 VAC	High	523-000090-51	910503705118	523-000091-51	910503705198	523-000092-51	910503705279
	Low	523-000090-19	910503705085	523-000091-19	910503705166	523-000092-19	910503705247
eW Cove QLX Powercore 220-240 VAC	High	523-000090-59	910503705126	523-000091-59	910503705207	523-000092-59	910503705287
	Low	523-000090-27	910503705093	523-000091-27	910503705174	523-000092-27	910503705255
eW Cove QLX Powercore 220-240 VAC Fixture and 10 ft (3 m) Leader Cable with terminator	High	523-000090-67	910503705134	523-000091-67	910503705215	523-000092-67	910503705295
	Low	523-000090-35	910503705102	523-000091-35	910503705182	523-000092-35	910503705263
eW Cove QLX Powercore 277 VAC	High	523-000090-75	910503705142	523-000091-75	910503705223	523-000092-75	910503705304
	Low	523-000090-43	910503705110	523-000091-43	910503705190	523-000092-43	910503705271

Use Item Number when ordering in North America.

Ordering Information - 4000 K*, Medium Beam (60° x 90°)

	Power Level	152 mm (6 in)		305 mm (12 in)		1220 mm (48 in)	
		Item Number	Philips 12NC	Item Number	Philips 12NC	Item Number	Philips 12NC
eW Cove QLX Powercore 120 VAC	High	523-000090-55	910503705122	523-000091-55	910503705203	523-000092-55	910503705283
	Low	523-000090-23	910503705089	523-000091-23	910503705170	523-000092-23	910503705251
eW Cove QLX Powercore 220-240 VAC	High	523-000090-63	910503705130	523-000091-63	910503705211	523-000092-63	910503705291
	Low	523-000090-31	910503705097	523-000091-31	910503705178	523-000092-31	910503705259
eW Cove QLX Powercore 220-240 VAC Fixture and 3 m (10 ft) Leader Cable with terminator	High	523-000090-71	910503705138	523-000091-71	910503705219	523-000092-71	910503705299
	Low	523-000090-39	910503705106	523-000091-39	910503705186	523-000092-39	910503705267
eW Cove QLX Powercore 277 VAC	High	523-000090-79	910503705146	523-000091-79	910503705227	523-000092-79	910503705308
	Low	523-000090-47	910503705114	523-000091-47	910503705194	523-000092-47	910503705275



* Color temperatures conform to nominal CCTs as defined in ANSI Chromaticity Standard C78.377A.

Use Item Number when ordering in North America.

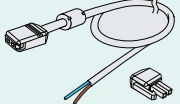
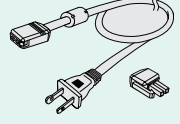

Submitted by Bright Focus Sales, Inc.		Catalog Number: 523-000092-51 / 108-000033-06 / 120 000076-01 / 120-000125-00 Notes:	Type: CV1 CLE15-11619
BRIGHTFOCUS	Job Name: MARTIN HALL		

Accessories

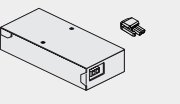
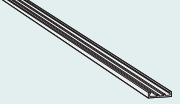
Item	Housing Color	Dimensions	Item Number	Philips 12NC		
Leader Cable (includes terminator), UL / cUL	Black	3 m (10 ft)	108-000032-10	912400130570		For connection to standard junction box
Leader Cable (includes terminator), CE / CCC	Black	3 m (10 ft)	108-000032-11	912400130571		
Leader Cable (includes terminator), UL / cUL	White	3 m (10 ft)	108-000032-12	912400130572		
Leader Cable (includes terminator), CE / CCC	White	3 m (10 ft)	108-000032-13	912400130573		
Leader Cable (includes terminator), UL, US Plug	Black	2.4 m (8 ft)	108-000032-14	912400130574		For portable installations
Jumper Cable, UL / cUL	White	305 mm (1 ft)	108-000033-06	910503700895		Depending on the installation's design, you may need jumper cables to add space between fixtures
		1.5 m (5 ft)	108-000033-07	910503700896		
Jumper Cable, CE / CCC	White	305 mm (1 ft)	108-000033-08	910503700897		
		1.5 m (5 ft)	108-000033-09	910503700898		
Wiring Compartment (includes terminator)	White	2.9 x 6.8 x 16 cm (1.17 x 2.7 x 6.32 in) (H x W x L)	120-000076-01	912400130576		Can be used for direct connection to conduit
Mounting Track	White	1219 mm (4 ft)	120-000125-00	910503701788		Optional mounting track ensures straight runs of fixtures

Use Item Number when ordering in North America.

Compatible Dimmers†

Supplier	Part Number	Description	Voltage
Philips	913701252701	Captivation Phase Dimmer DC-DPD-I-1S-101	120 VAC
Philips	913703021009	DTE310	230 VAC
Philips	912400133633	Data Adapter, DALI to ELV, DigiDim 452	230 VAC
Philips	913701252701	Captivation Phase Dimmer DC-DPD-I-1S-101	277 VAC
Philips Strand	A21 with IGBT module	A21 Dimmer Cabinet with IGBT Dimmer Module	120 VAC
Philips Strand	A21 with IGBT module	A21 Dimmer Cabinet with IGBT Dimmer Module	277 VAC
Lutron	NTELV-600	Nova T Electronic Low Voltage Dimmer	120 VAC
Lutron	PHPM-PA-DV-WH	Phase-Adaptive Power Module	120 VAC
Lutron	PHPM-PA-DV-WH	Phase-Adaptive Power Module	277 VAC

† These dimmers have been tested in our lab and found to be compatible with this product. All installations are different. We highly recommend performing a full mockup of every lighting circuit, including all luminaires and controls, to test for the desired dimming range. Visit <http://1.usa.gov/1g3cGfs> for more information.

Submitted by Bright Focus Sales, Inc.	Job Name: MARTIN HALL	Catalog Number: 523-000092-51 / 108-000033-06 / 120 000076-01 / 120-000125-00	Type: CV1
BRIGHTFOCUS		Notes:	CLE15-11619

Copyright © 2015 Philips Solid-State Lighting Solutions, Inc. All rights reserved. Chromacore, Chromasic, CK, the CK logo, Color Kinetics, the Color Kinetics logo, ColorBlast, ColorBlaze, ColorBurst, ColorGraze, ColorPlay, ColorReach, iW Reach, eV Reach, DiMand, EssentialWhite, eV, iColor, iColor Cove, IntelliWhite, iW, iPlayer, Optibin, and Powercore are either registered trademarks or trademarks of Philips Solid-State Lighting Solutions, Inc. in the United States and / or other countries. All other brand or product names are trademarks or registered trademarks of their respective owners. Due to continuous improvements and innovations, specifications may change without notice.

DAS-000068-05 R08 02-15



Philips Color Kinetics
 3 Burlington Woods Drive
 Burlington, Massachusetts 01803 USA
 Tel 888.385.5742
 Tel 617.423.9999
 Fax 617.423.9998
www.philipscolorkinetics.com
 @colorkinetics



Date: _____ Type: _____

Firm Name: _____

Project: _____

eW Cove QLX Powercore

Performance interior linear LED cove and accent fixture with solid white light

Ordering Information

eW Cove QLX Powercore is a dimmable, linear LED fixture that provides an affordable, energy-efficient alternative to traditional cove lighting in applications requiring white light. With its low profile, rotating housing and flexible end-to-end locking power connectors, eW Cove QLX Powercore is the perfect choice for a wide range of interior retail, exhibit, hospitality, and architectural settings.

- Industry-best white-light quality and color consistency — Advances in Optibin, Philips proprietary binning optimization process, now provides color-consistency within a 2-step MacAdam ellipse across eW Cove product fixtures and manufacturing runs.
- Uncompromised Performance — Efficacies of near 100 lm/w provide optimum output without restrictions on lumen maintenance, operating temperature or warranty.
- Multiple options for design flexibility — Available in four color temperatures ranging from a warm 2700 K to a cool 4000 K. Lengths of 152 mm (6 in), 305 mm (12 in), and 1220 mm (48 in), wide and medium beam angles, and two power levels offer further design flexibility.
- Support for multiple voltages — Accepts power input of 120, 220 – 240, or 277 VAC for consistent installation and operation from line voltage in many locations.

Smooth dimming capability — Patented DIMand technology offers smooth dimming capability with selected reverse-phase ELV-type dimmers.

For detailed product information, please refer to the eW Cove QLX Powercore Product Guide at www.philipscolorkinetics.com/ls/essentialwhite/ewcoveqlxpc/

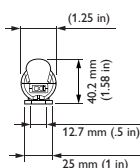

Medium Beam
60° x 90°

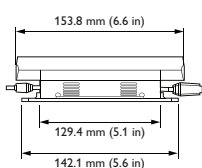

Wide Beam
110° x 110°

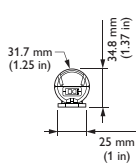

Medium Beam
60° x 90°

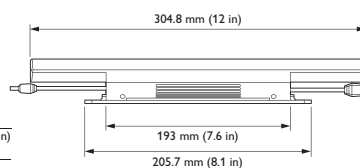

Wide Beam
110° x 110°

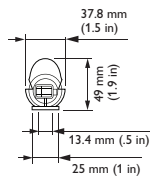
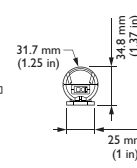

Medium Beam
60° x 90°

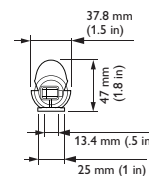
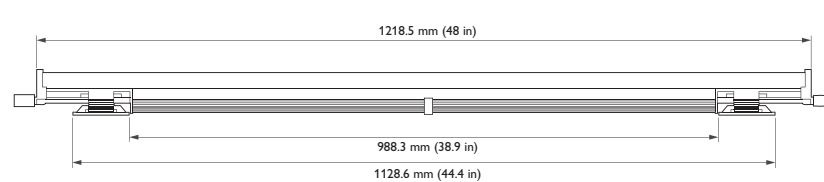

Wide Beam
110° x 110°



Ordering Information - 3500 K*, Wide Beam (110° x 110°)

	Power Level	152 mm (6 in)		305 mm (12 in)		1220 mm (48 in)	
		Item Number	Philips 12NC	Item Number	Philips 12NC	Item Number	Philips 12NC
eW Cove QLX Powercore 120 VAC	High	523-000090-50	910503705117	523-000091-50	910503705197	523-000092-50	910503705278
	Low	523-000090-18	910503705084	523-000091-18	910503705165	523-000092-18	910503705246
eW Cove QLX Powercore 220-240 VAC	High	523-000090-58	910503705125	523-000091-58	910503705206	523-000092-58	910503705286
	Low	523-000090-26	910503705092	523-000091-26	910503705173	523-000092-26	910503705254
eW Cove QLX Powercore 220-240 VAC Fixture and 3 m (10 ft) Leader Cable with terminator	High	523-000090-66	910503705133	523-000091-66	910503705214	523-000092-66	910503705294
	Low	523-000090-34	910503705101	523-000091-34	910503705181	523-000092-34	910503705262
eW Cove QLX Powercore 277 VAC	High	523-000090-74	910503705141	523-000091-74	910503705222	523-000092-74	910503705303
	Low	523-000090-42	910503705109	523-000091-42	910503705189	523-000092-42	910503705270

Use Item Number when ordering in North America.

Ordering Information - 3500 K*, Medium Beam (60° x 90°)

	Power Level	152 mm (6 in)		305 mm (12 in)		1220 mm (48 in)	
		Item Number	Philips 12NC	Item Number	Philips 12NC	Item Number	Philips 12NC
eW Cove QLX Powercore 120 VAC	High	523-000090-54	910503705121	523-000091-54	910503705202	523-000092-54	910503705282
	Low	523-000090-22	910503705088	523-000091-22	910503705169	523-000092-22	910503705250
eW Cove QLX Powercore 220-240 VAC	High	523-000090-62	910503705129	523-000091-62	910503705210	523-000092-62	910503705290
	Low	523-000090-30	910503705096	523-000091-30	910503705177	523-000092-30	910503705258
eW Cove QLX Powercore 220-240 VAC Fixture and 3 m (10 ft) Leader Cable with terminator	High	523-000090-70	910503705137	523-000091-70	910503705218	523-000092-70	910503705298
	Low	523-000090-38	910503705105	523-000091-38	910503705185	523-000092-38	910503705266
eW Cove QLX Powercore 277 VAC	High	523-000090-78	910503705145	523-000091-78	910503705226	523-000092-78	910503705305
	Low	523-000090-46	910503705113	523-000091-46	910503705193	523-000092-46	910503705272

Use Item Number when ordering in North America.

Ordering Information - 4000 K*, Wide Beam (110° x 110°)

	Power Level	152 mm (6 in)		305 mm (12 in)		1220 mm (48 in)	
		Item Number	Philips 12NC	Item Number	Philips 12NC	Item Number	Philips 12NC
eW Cove QLX Powercore 120 VAC	High	523-000090-51	910503705118	523-000091-51	910503705198	523-000092-51	910503705279
	Low	523-000090-19	910503705085	523-000091-19	910503705166	523-000092-19	910503705247
eW Cove QLX Powercore 220-240 VAC	High	523-000090-59	910503705126	523-000091-59	910503705207	523-000092-59	910503705287
	Low	523-000090-27	910503705093	523-000091-27	910503705174	523-000092-27	910503705255
eW Cove QLX Powercore 220-240 VAC Fixture and 10 ft (3 m) Leader Cable with terminator	High	523-000090-67	910503705134	523-000091-67	910503705215	523-000092-67	910503705295
	Low	523-000090-35	910503705102	523-000091-35	910503705182	523-000092-35	910503705263
eW Cove QLX Powercore 277 VAC	High	523-000090-75	910503705142	523-000091-75	910503705223	523-000092-75	910503705304
	Low	523-000090-43	910503705110	523-000091-43	910503705190	523-000092-43	910503705271

Use Item Number when ordering in North America.

Ordering Information - 4000 K*, Medium Beam (60° x 90°)

	Power Level	152 mm (6 in)		305 mm (12 in)		1220 mm (48 in)	
		Item Number	Philips 12NC	Item Number	Philips 12NC	Item Number	Philips 12NC
eW Cove QLX Powercore 120 VAC	High	523-000090-55	910503705122	523-000091-55	910503705203	523-000092-55	910503705283
	Low	523-000090-23	910503705089	523-000091-23	910503705170	523-000092-23	910503705251
eW Cove QLX Powercore 220-240 VAC	High	523-000090-63	910503705130	523-000091-63	910503705211	523-000092-63	910503705291
	Low	523-000090-31	910503705097	523-000091-31	910503705178	523-000092-31	910503705259
eW Cove QLX Powercore 220-240 VAC Fixture and 3 m (10 ft) Leader Cable with terminator	High	523-000090-71	910503705138	523-000091-71	910503705219	523-000092-71	910503705299
	Low	523-000090-39	910503705106	523-000091-39	910503705186	523-000092-39	910503705267
eW Cove QLX Powercore 277 VAC	High	523-000090-79	910503705146	523-000091-79	910503705227	523-000092-79	910503705308
	Low	523-000090-47	910503705114	523-000091-47	910503705194	523-000092-47	910503705275

* Color temperatures conform to nominal CCTs as defined in ANSI Chromaticity Standard C78.377A.

Use Item Number when ordering in North America.

